

60xEOS600-RACK

Modular Seismic Horizontal Battery Rack – 10Wide x 6High (84.4”L x 16.9”D x 72.5”H)

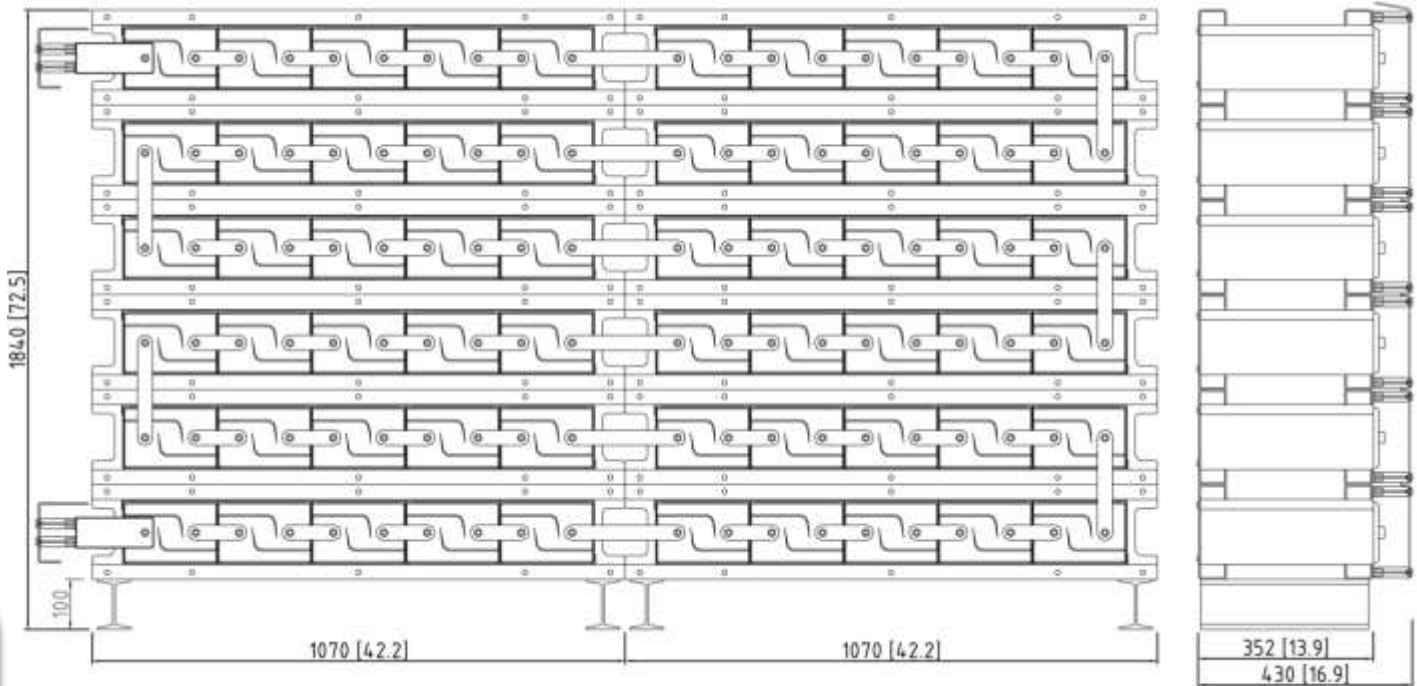

PARTS LIST:

1. Terminal Connection Bus (Pos & Neg)	2pcs
2. Cell-to-Cell bars:	48pcs
3. Module-to-Module bars:	5pcs
4. Rack-to-Rack bars:	6pcs
5. Battery Eos-AGM-600	60pcs
6. 30xEOS600-RACK Horizontal Battery Rack	2pcs

Rack Weight: 1287 lbs.